

Getting Started

Congratulations on the purchase of a LAVASynC+ product! The LAVASynC+ product family makes it possible to simultaneously charge select USB-C Samsung mobile devices while working with various USB peripherals such as printers, mice, keyboards, and even external hard drives. This mode of operation is called SimulCharge.

In addition to simultaneous charging, all LAVASynC+ products support LAVA's Recovery & Battery Modulation (i.e. RBM) technology when coupled with the LAVA Tablet Manager Application (LTM).

The LAVASynC+ extended features rely on the LAVA product working in unison with the LTM application, therefore the installation of LTM is mandatory prior to using a LAVASynC+ product. LTM is available as part of a Software Release Package which contains the LTM.apk file and extra utilities that may be useful. The package may be downloaded in the form of a zip file from a web link that is provided by LAVA Sales/Support. You may contact LAVA by phone: +1-800-241-LAVA (5282), or email: sales@lavalink.com.

The LAVASynC+ product line provides the following features:

- Access USB peripherals while simultaneously charging a mobile device
- Keep a mobile device connected to power 24/7
- Maintain battery health
- Modulate charging based on actual battery charge levels
- Manage Screen Brightness based on time of day
- Attach multiple USB Peripherals at any time
- Connect and access multiple USB Peripherals (product specific)
- Provide a wired Ethernet connection to a mobile device (product specific)
- Power mobile device via PoE (product specific)
- Power via an unregulated DC power supply (product specific)

Your hardware purchase will include:

- LAVASynC+ device

Prior to proceeding with the instructions in this document, ensure you have obtained:

- A compatible USB C Samsung mobile device (tablet or mobile phone)
- A USB-C to USB-C cable which supports **both data and charging**

Software Setup

Required parts:

- LTM.apk file
- Compatible Samsung mobile device (tablet or mobile phone)

1. Download LAVA Software Release Package

The LAVA Software Release Package may be downloaded from a web link in the form of a zip file, and therefore needs to be extracted/unzipped. The zip file can be extracted from a web browser on the mobile device or a PC, using one of many online extraction tools that are freely available. If the zip file is extracted on a PC, it will need to be transferred onto the mobile device using a memory stick and an OTG adapter such as the LAVA Charge-Plus for USB-C receptacles.

2. Allow mobile device to install apps from unknown sources

Since the Software Release Package is not downloaded from the Google Play Store, the mobile device will need permission to install apps from unknown sources.

- Open the mobile device Settings.
- Click "Biometrics and security".*
- In the Biometrics and security menu, click "Install unknown apps".
- Locate the browser application (if using mobile device) or memory stick (if using PC) you are using to install LTM.
- Click on the icon containing the name of the application or memory stick.
- Enable "Allow from this source" (Figure 1).



Figure 1: Example of web browser application being permitted to install unknown apps

***Note:** If your mobile device is operating with Android version 7 or lower, step b) will require you to click "Lock screen and security" in the mobile device Settings.

3. Locate the LTM.apk file

LTM.apk will be located in the Software Release Package folder in "My Files" on your mobile device.

-If the package was downloaded from a web browser, it will be located in "Downloads".**

-If the package was placed on a memory stick, it will be located in "USB storage", in which case you must move it into the "Downloads" folder.

LTM will appear as "LTM(v4.xx).apk" in the Software Release Package folder.

****Note:** If you downloaded the software package from a web browser on your mobile device, the apk file may be located in "Installation files" as well as "Downloads".

4. Install and open LTM.apk

Click on the LTM.apk file in order to install it.

Once LTM has been installed on your device, you will receive a pop-up message providing the option to open the application.

Click "Open" (Figure 2).

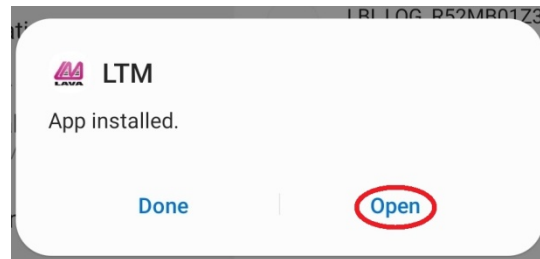

Figure 2: Pop-up message providing option to open LTM

5. Give LTM access to photos, media, and files.

When you open LTM for the first time, you will receive a pop-up message requesting permission for LTM to access photos and media on your device.

Click "Allow" to grant permission (Figure 3).

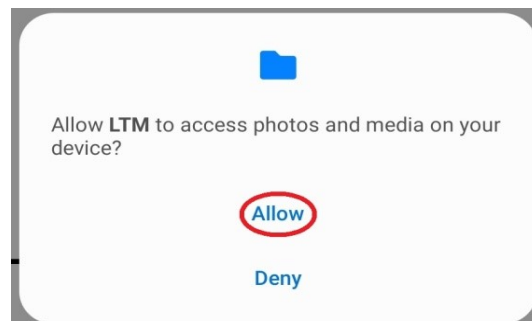

Figure 3: Pop-up message from LTM requesting access to device files

6. Configure the application settings***

a) You will receive an "LTM Startup" pop-up, which will automatically direct you to Configuration settings.

Click "OKAY" (Figure 4).

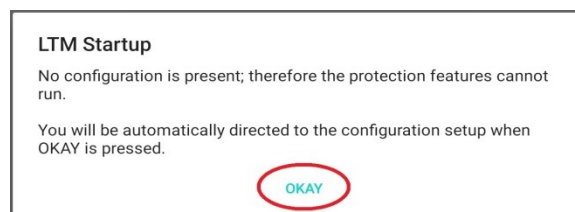

Figure 4: LTM Startup pop-up

*****Note:** If you have used an older version of the LTM application in the past, you will be given the option to import a legacy configuration file which contains the settings that were previously used. See the LTM Advanced Utilities document in the Software Release Package for detailed instructions on importing the legacy configuration.

b) You will see a “Configuration Not Found” pop-up. Click “OKAY” (Figure 5).

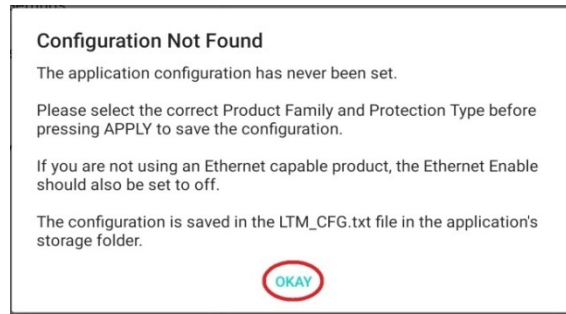

Figure 5: Configuration Not Found pop-up

c) In General Settings (Figure 6), the Product Family must be set according to the LAVA product being used (in this case, SynC+). The Protection Type must also be set according to the mobile device being used. For a list of mobile devices and their suggested Protection Types, select the link located in the Protection Type menu. Incorrectly setting the Product Family or Protection Type can lead to serious operational issues.

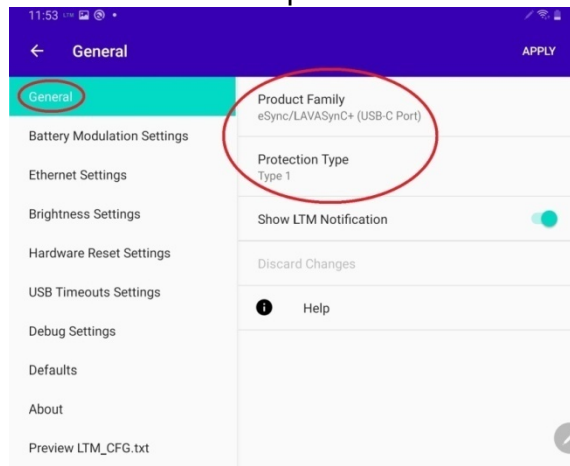

Figure 6: General Settings in the Go To Configuration menu

c) If a non-Ethernet LAVA product is being used, Ethernet Enabled should be turned off in Ethernet Settings (Figure 7).

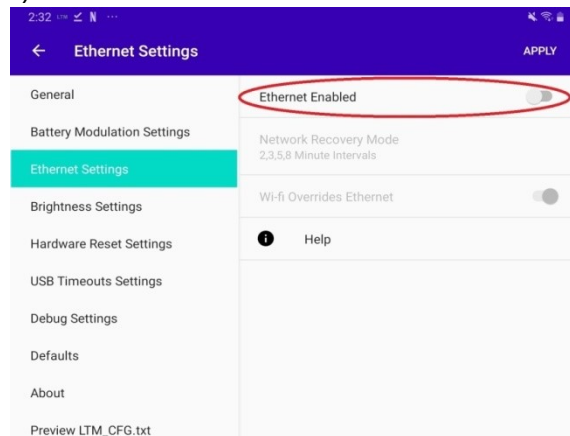

Figure 7: Ethernet Enabled turned off

7. Once you are satisfied with your configured settings, click “Apply” in the top right corner of the screen. Then, click the arrow in the top left corner of the screen (Figure 8) to return to the LTM homepage.

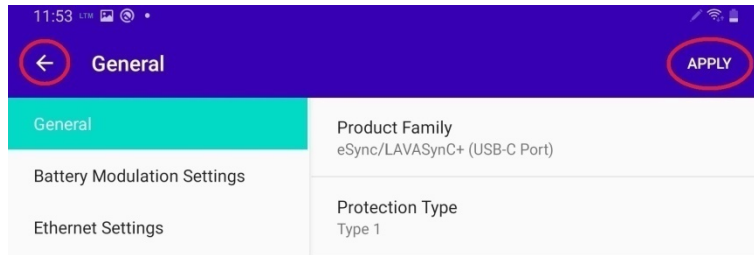

Figure 8: Buttons to apply changes and return to home screen

8. Proceed to the “Hardware Setup” section of this document.

Note: For information regarding additional recommended features and applications that can be used with LTM, see the LTM Advanced Utilities document.

Hardware Setup

Required Parts:

- LAVASynC+ product
- USB-C to USB-C cable that supports both **data and charging**
- Compatible Samsung mobile device (such as tablet or mobile phone)
- Samsung USB Charger & Charging Cable (included with the mobile device)

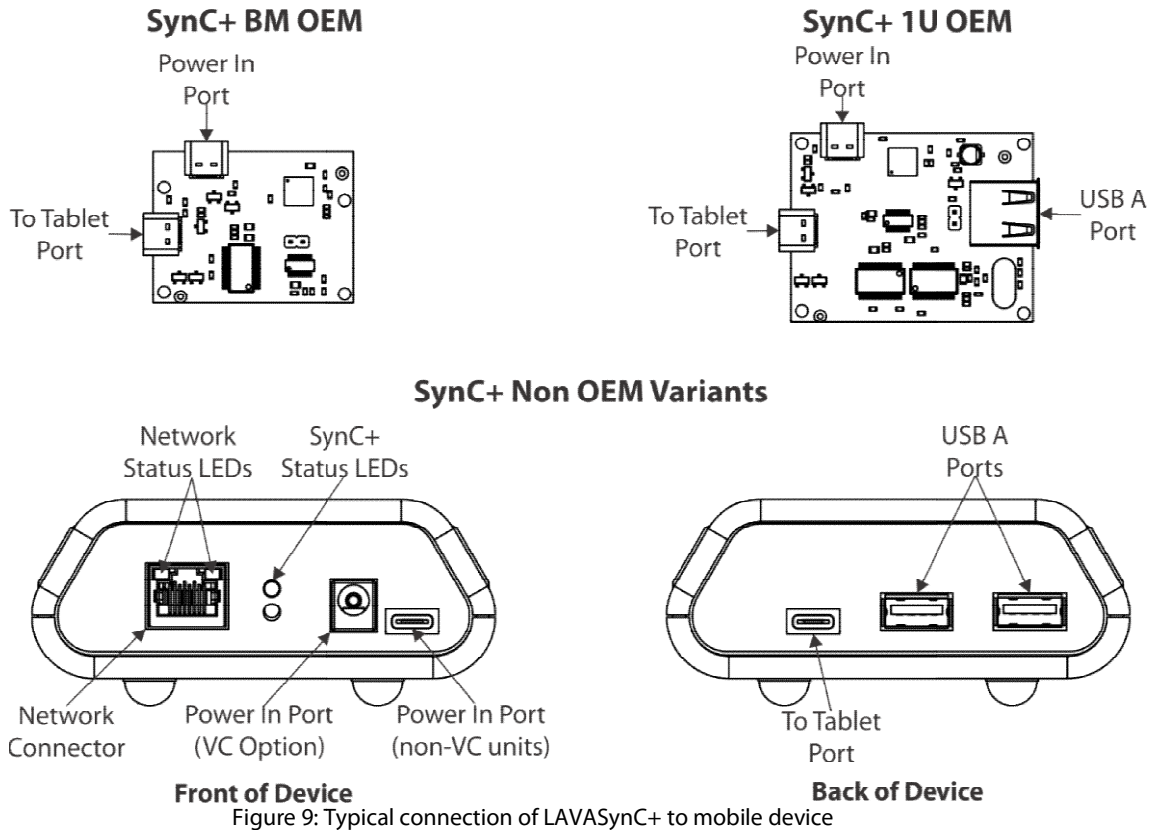

Setup Procedure:

1. Plug the Samsung USB Charger into an AC power source and connect the USB-C connector into the LAVASynC+ port marked "USB-C Power Adapter".
 - **For PoE units:** Select LAVASynC+ devices can be powered using a PoE Switch/Injector connected to the Ethernet Port.
 - **For VC units:** Select LAVASynC+ devices can be powered using a 9-36V (12W or better) power supply, with a 2.1 mm center positive barrel jack connector, connected to the port marked "9-36 VDC In". The attached power supply and wiring are responsible for providing short circuit protection.

Note: If using either PoE, or the VC power input, **do not** plug a power supply into the port marked "Micro-B USB Aux 5V".

Note: For VC units, when connecting the LAVA product to the supply, ensure the wiring is such that the center pin is positive. If the polarity is reversed the damage to the LAVA product is immediate. Application of the wrong input voltage violates LAVA's Manufacturer Warranty.

2. Once the product is powered, the Yellow LAVASynC+ status LED light will start blinking, indicating that the unit is receiving power.
3. Plug one end of the USB-C to USB-C cable into the mobile device. Plug the other end into the LAVASynC+ port marked "Mobile Device".
4. Once the LAVA product is powered and connected to your mobile device, you will receive a pop-up message regarding opening LTM when a USB is connected. You will receive this pop-up every time you connect your mobile device to a LAVASynC+ product, unless you click "Always open LTM...".
Click "OK" (Figure 10).

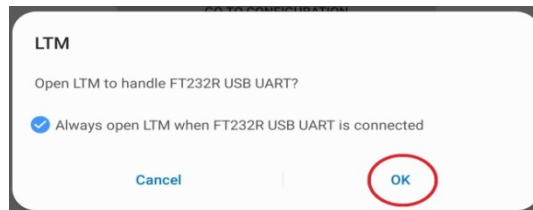

Figure 10: Pop-up message received upon connecting LAVA product to mobile device

5. Once the USB-C cable is attached, the Green LAVASynC+ status LED light will be illuminated, indicating that a connection has been established with the mobile device.
6. To verify that LTM has detected the hardware connection, consult the "STATUS" window on the LTM homepage on your mobile device. Prior to connecting your LAVA product, the "STATUS" window will say "CONTROLLER NOT DETECTED" (Figure 11).

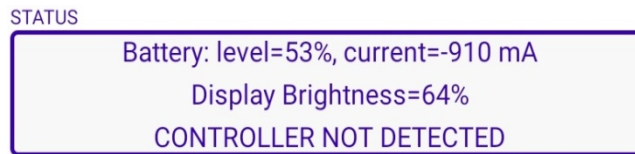

Figure 11: STATUS window prior to connection of the LAVA product

Once you see “Controller detected” in the STATUS window (Figure 12), the LTM application has successfully detected the LAVA hardware.

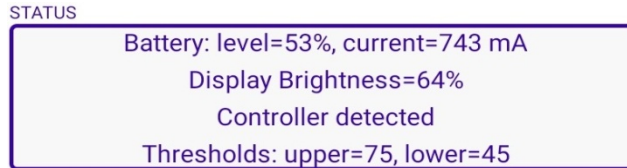

Figure 12: STATUS window upon detecting a connection to the LAVA product

If your product is functioning properly, “Controller detected” will be replaced by a “Controller ran @hh:mm:ss” (hour:minute:second) time which will update approximately every 30 seconds (Figure 13).

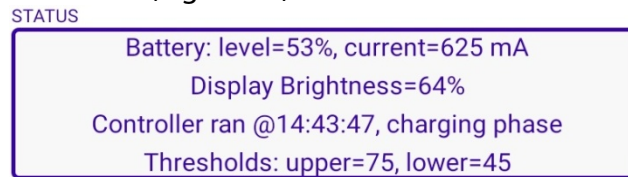

Figure 13: STATUS window once the product is functioning properly with LTM

7. After establishing a connection with the mobile device, the Yellow SynC+ status LED light will begin blinking on and off to indicate whether the LAVASynC+ product is in a charge cycle (eg. Yellow LED is mostly on and briefly off) or discharge cycle (eg. Yellow LED is briefly on and mostly off). The STATUS window on the LTM home screen will also indicate if it is charging or discharging, with a message that says “charging phase” or “discharging phase” (Figure 13).
8. Plug your peripherals and/or Ethernet cable into the LAVASynC+ product (if applicable).

Concluding Steps

Step 1. Enable Screen Brightness Management (optional)

If you would like to install or learn more about the Screen Brightness Management feature, refer to the “Advanced LTM Settings” document. This step is **strongly** recommended, but optional.

Step 2. Set LTM to Background Mode once ready for deployment

- a) The LTM and hardware setup process is now complete. Once you have verified your setup and you are satisfied with your configuration, you may set the LTM application to Background Mode.
- b) On the LTM homepage, press the Overflow menu (3 vertical dots) in the top right corner.
- c) Select “Background Mode”.
- d) If the application disappears from view, it has been set to Background Mode successfully.

Revert LTM to Configuration Console

When LTM is in Background Mode, it cannot be opened by simply clicking the application logo on the mobile device home screen. There are two ways to revert the application into Configuration Console:

1. Close all active applications on the mobile device. Once they have been cleared, clicking the LTM app once will launch it in a visible state.
2. Click the LTM logo several times within a few seconds.

Wired Ethernet Configuration (for Ethernet capable products)

Depending on your mobile device and network configuration, you may need to enable or reconfigure the wired connection settings on your device.

After establishing a connection with the LAVASynC+ product, the Ethernet configuration option should be available on the Settings Menu of your mobile device (i.e. Settings > Connections > More connection settings > Ethernet).

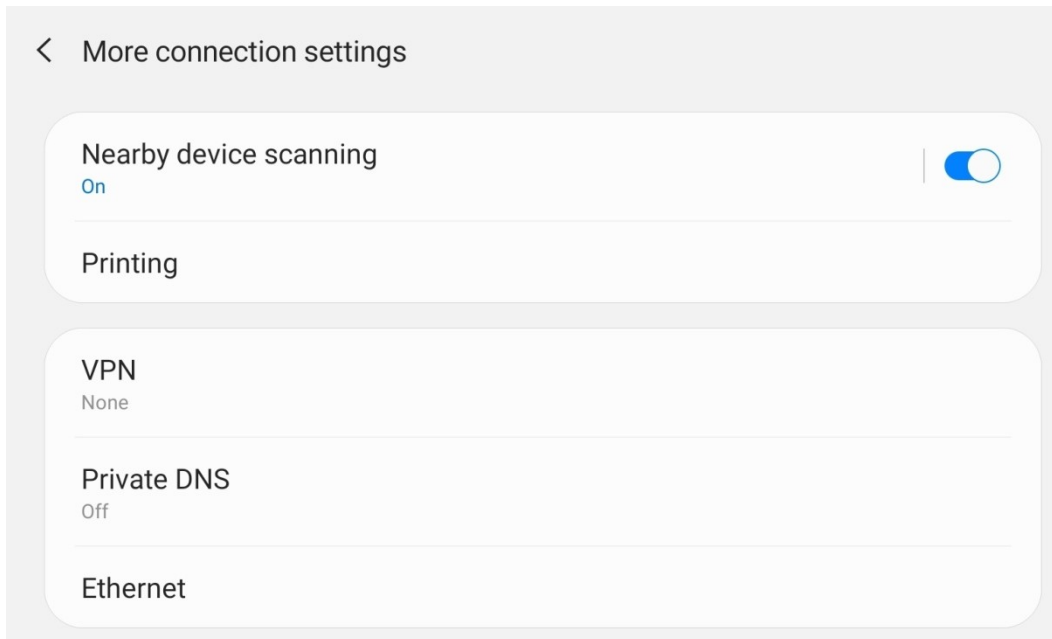

Figure 14: More connection settings on mobile device

After establishing a connection with the LAVASynC+, if the Ethernet option is greyed out or unavailable, the mobile device likely does not support a wired connection. If this is the case there is likely nothing that can be done to enable this feature on your mobile device.

Assuming that the Ethernet option is available it may be necessary to enable or disable the wired connection on your mobile device. This can be done by ensuring the Ethernet option is enabled or disabled on the Ethernet page.

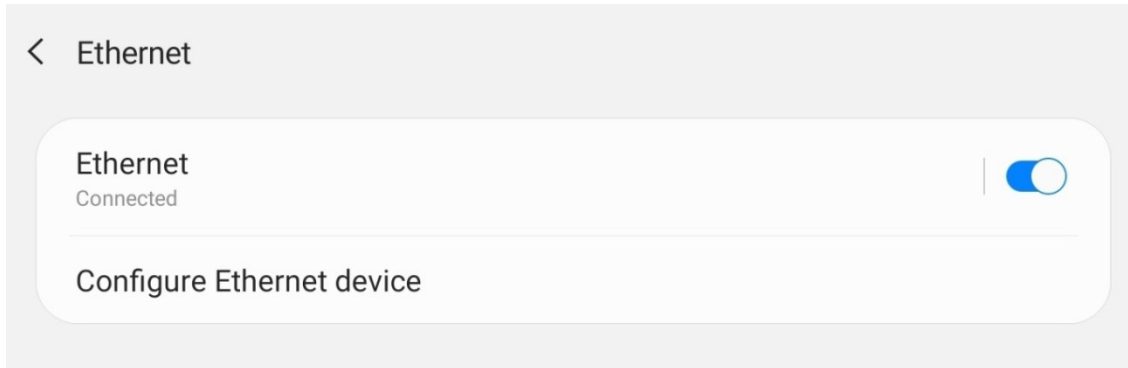

Figure 15: Ethernet enabled on mobile device

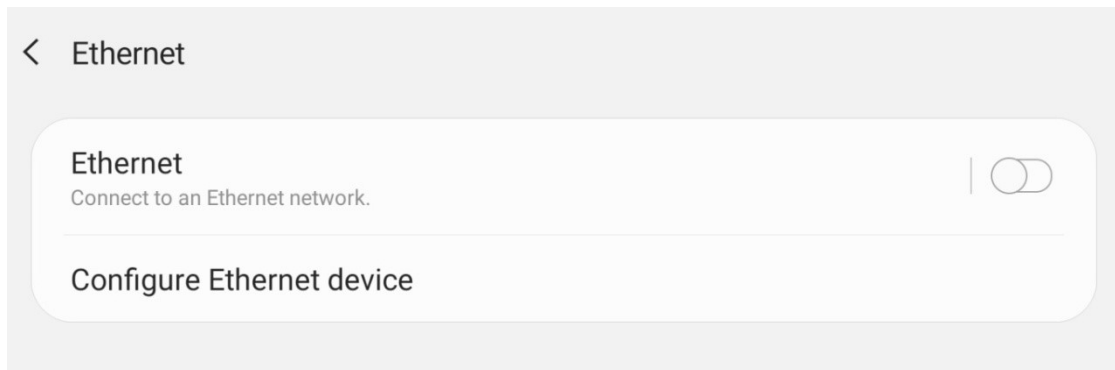

Figure 16: Ethernet disabled on mobile device

Most mobile devices will have DHCP enabled by default. If your network does not have a valid DHCP server, you will need to manually configure an IP Address for the mobile device. Check with your network administrator before using static IP settings.

To manually configure an IP Address you will need to disable the Ethernet connection on the Ethernet page before selecting "Configure Ethernet Device". From here you can select "Static IP" and specify the IP Address settings to be used by the mobile device.

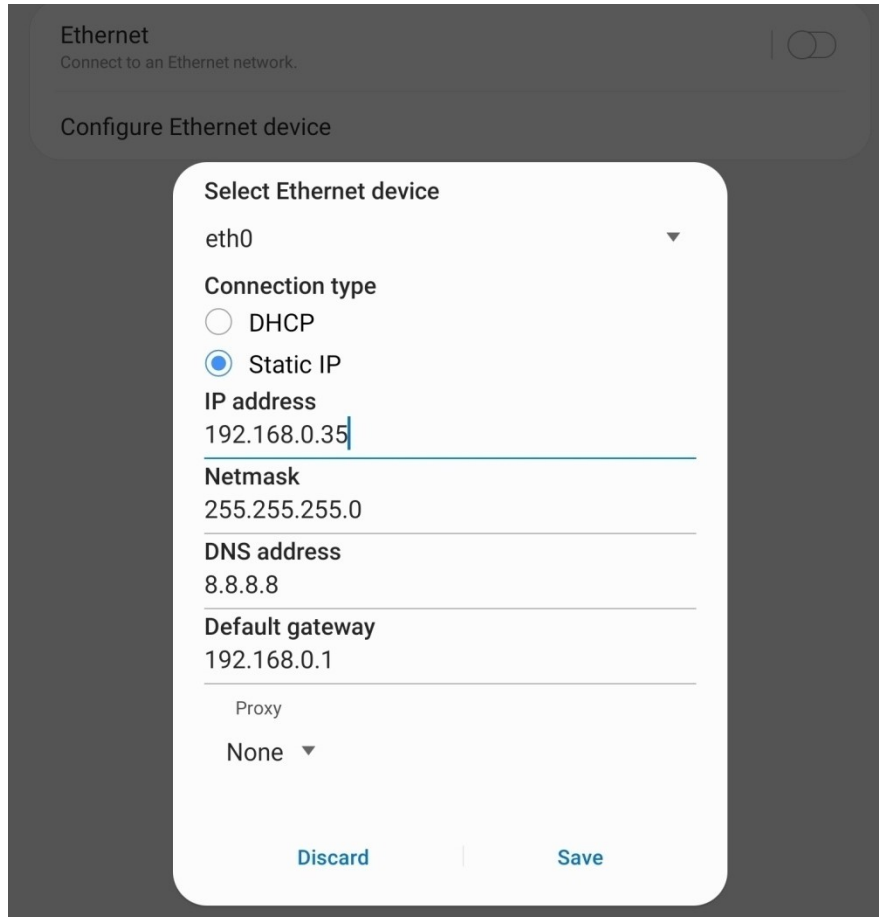

Figure 17: Example of Static IP configuration on mobile device

Once the IP Address has been configured you will need to re-enable the Ethernet connection in order to use the wired connection.

LAVA

Technical Support

9:00 am to 5:00 pm Monday to Friday (Eastern Time)

Tel: +416 674-5942

E-mail: tech@lavalink.com

Internet: www.lavasimulcharge.com



This device complies with part 15 of the FCC Rules. Operation is subject to the following conditions: (1) This device may not cause harmful interference, and (2) this device must accept any interference received, including interference that may cause undesired operation.

Lava Computer MFG Inc. 908 Niagara Falls Blvd. #629. North Tonawanda NY 14120-2060